



DES 24MX



Telai divisibili per cavi con e senza connettori

CARATTERISTICHE

- Soluzione modulare
- Molteplici configurazioni con gommini piccoli e grandi
- Viti di chiusura telaio in AISI304
- Protezione IP54
- Tenuta cavo sec. EN 62444
- Robusto IK10
- Guarnizione esterna inclusa nella confezione

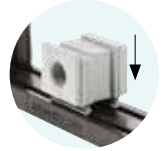

I telai divisibili DES 24MX permettono il passaggio di un numero elevato di cavi con e senza connettori con diametri da 2 a 35 mm. Il sistema modulare e la guida a scorrimento tipica dei telai DES permettono l'utilizzo di cavi di piccole o di grandi dimensioni liberamente ed in quantità. Eventuali futuri utilizzi del telaio possono venir programmati tramite i gommini ciechi a perforazione.





Materiale: PP+GF, senza alogeni e siliconi

Infiammabilità: autoestinguente sec. UL94-V0

Temperatura: -40°C... +155°C (statica)

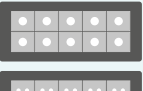
PRODOTTI CORRELATI

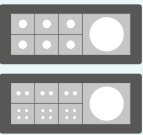
- Gommini SPP (da pag. 48)
- Gommini SPG (da pag. 54)
- DES caps (pag. 63)

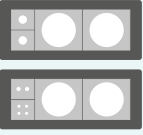
Modello	Codice	Alcune configurazioni per modulo	Dimensioni B x H (mm)	Apertura max. (mm)	Pz (x conf.)
 DES 24MX2	1731010252		146 x 115	114 x 92	1
 DES 24MX3	1731010253		146 x 167	114 x 144	
 DES 24MX4	1731010254		146 x 219	114 x 196	
Altri modelli su richiesta					
Su richiesta	1731991020	Set di 4 viti di fissaggio in AISI304 con finitura Black Geomet			

Dimensioni (mm)

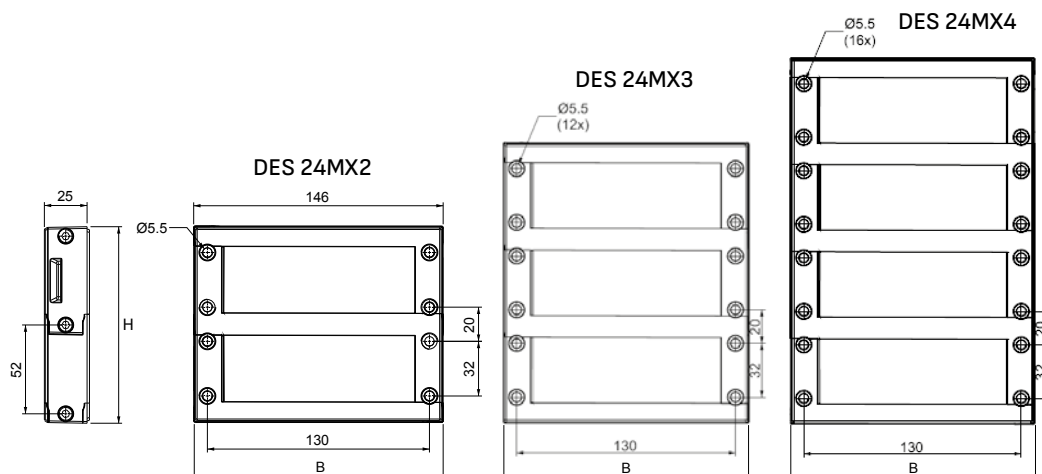

Tutorial



IP54

NEMA 12



ECOLAB



RoHS COMPLIANT

IK10