



DES 16MX



Telaio divisibile per cavi con e senza connettori

CARATTERISTICHE

- Soluzione modulare
- Molteplici configurazioni con gommini piccoli e grandi
- Viti di chiusura telaio in AISI304
- Protezione IP54
- Tenuta cavo sec. EN 62444
- Robusto IK10
- Guarnizione esterna inclusa nella confezione



I telai divisibili DES 16MX permettono il passaggio di un numero elevato di cavi con e senza connettori con diametri da 2 a 35 mm. Il sistema modulare e la guida a scorrimento tipica dei telai DES permettono l'utilizzo di cavi di piccole o di grandi dimensioni liberamente ed in quantità. Eventuali futuri utilizzi del telaio possono venir programmati tramite i gommini ciechi a perforazione.





Materiale: PP+GF, senza alogeni e siliconi

Infiammabilità: autoestinguente sec. UL94-V0

Temperatura: -40°C... +155°C (statica)

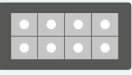
PRODOTTI CORRELATI

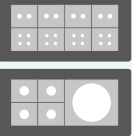
- Gommini SPP (da pag. 48)
- Gommini SPG (da pag. 54)
- DES caps (pag. 63)

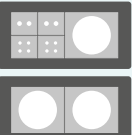
Modello	Codice	Alcune configurazioni per modulo	Dimensioni (mm)	Apertura max. (mm)	Pz (x conf.)
 DES 16MX2	1731010262		120 x 115	86 x 92	1
 DES 16MX3	1731010263		120 x 167	86 x 144	
 DES 16MX4	1731010264		120 x 219	86 x 196	
Altri modelli su richiesta					
Su richiesta	1731991020	Set di 4 viti di fissaggio in AISI304 con finitura Black Geomet			

Dimensioni (mm)

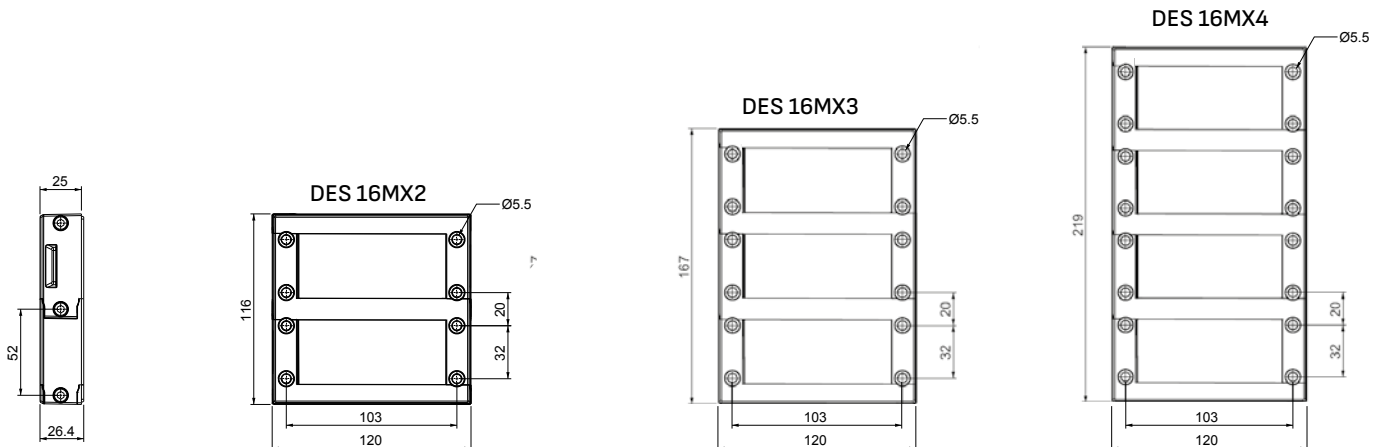

IP54

NEMA 12



ECOLAB



IK10