









# DESCCLICK 50

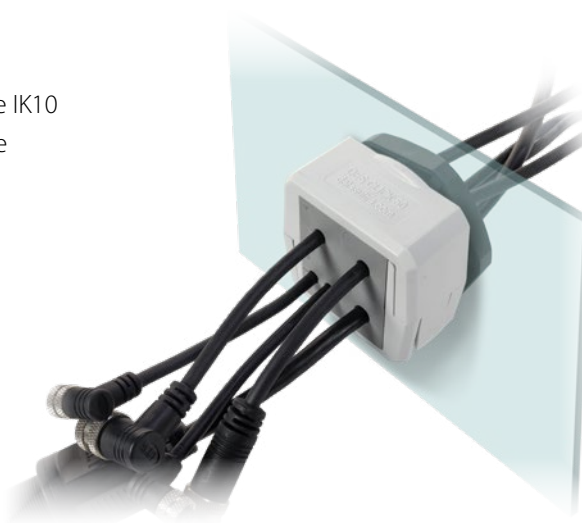

## Presses étoupes divisibles

- ▶ Fixation sans vis
- ▶ Filet métrique M50
- ▶ IP54
- ▶ Résistance mécanique IK10
- ▶ Couleurs grise et noire



Type	Code	Tailles maximales des joints			Ouverture Ø [mm]	Cond.
 DESCCLICK 50B	1731051050				50,5	10
 DESCCLICK 50G	1731051350	SPP 15	SPP 2x6	SPP 4x3		

**Exemples de configuration**



DES CLICK 50 est un presse étoupe divisible qui utilise des ouvertures au pas métrique M50.

DES CLICK 50 peut être équipé avec des joints passe-câbles petits, grands et multiples.

Avec des joints passe-câbles multiples il est possible de passer 16 câbles.

### Caractéristiques





**Matière:** PC

**Inflammabilité:** autoextinguible suivant UL94-V0

**Température:** -40°C... +130°C (statique)

**Propriété:** sans halogènes, sans silicone

### Accessoires

-  Joint fendu SPG
  -  Joint fendu SPP
  -  Joint fendu SPP 2x
  -  Joint fendu SPP 4x
- Poinçonneuse hydraulique HY360



### Dimensions [mm]

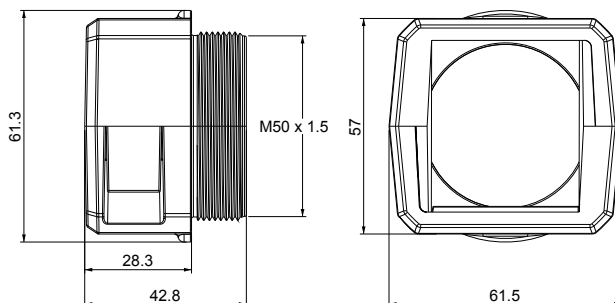

IP54

NEMA 12



IK10

