



DESCCLICK 50



Divisible cable glands with locknut

FEATURES

- Without screws
- Strain relief according to EN 62444
- M50 metric size
- Sturdy construction IK10
- IP54

DESCCLICK 50 is a divisible cable gland with M50 thread. It includes the M50 nut. DESCCLICK 50 can be used for small, multiple, perforable and big grommets for cables with or without connectors.

Material: PC, halogens and silicones free





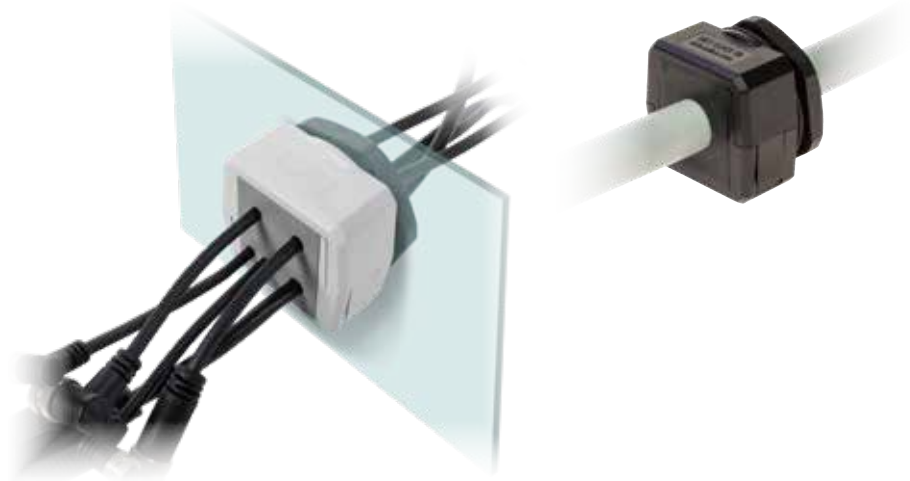

Flammability: self-extinguishing acc. to UL94-V0

Temperature: -40°C... +130°C (static)

RELATED PRODUCTS

- SPP grommets (from page 46)
- SPG grommets (from page 52)
- HY360 hydraulic punch driver (page 139)
- Divisible locknuts (page 39)



Model	Code	Max. grommet sizes				Max. cut-out (Ø mm)	Pcs (/pack)
 DESCCLICK 50B	1731051050					50,5	10
 DESCCLICK 50G	1731051350	SPP 15	SPP 2 x 6	SPP 4 x 3	SPG 34		

Some possible configurations



Dimensions (mm)

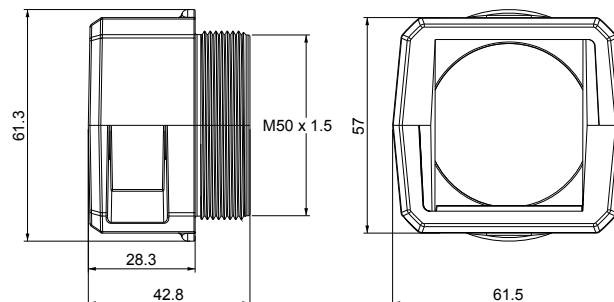

Tutorial



IP54

NEMA 12

UL TYPE 12

UL94-V0



IK10