



DES L1 / L2 / L3



Splittable frame for cables with and without connectors

FEATURES

- For 1, 2 or 3 small SPP grommets
- Frame screws in AISI304 Stainless Steel
- IP66 and NEMA 4X* certified with all configurations of grommets
- Strain relief according to EN 62444
- Sturdy construction IK10
- Overmolded gasket acc. to UL94-V0
- ATEX version on request (Group 7)
- Threaded inserts version on request



The DES L1, L2, L3 cable entry system consists of a splittable frame designed to accommodate small (SPP) grommets for cables with or without connectors. With all combinations of grommets, single, double, quadruple, the IP66 and NEMA 4X* are guaranteed. The overmolded gasket guarantees faster installation times and the complete V0 self-extinguishing of the system.

Material: PP+GF, halogens and silicones free
Flammability: self-extinguishing acc. to UL94-V0
Temperature: -40°C... +155°C (static)

RELATED PRODUCTS

- SPP grommets (from page 46)
- HY360 hydraulic punch driver (page 139)
- DES caps (page 61)

Model	Code	Some possible configurations	Max. cut-out (mm)	Pcs (/pack)
NEW DES L1	1731010001		21 x 18	10
DES L2	1731010002		40 x 18	
DES L3	1731010003		63 x 18	
Upon request	1731991010	Set of 2 mounting screws in AISI304 with Black Geomet finishing		

Dimensions (mm)



* Indoor only

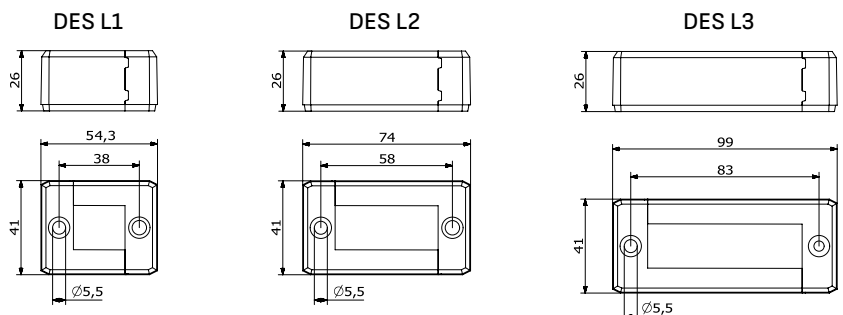

IP66

NEMA 12, 4X*

UL TYPE 12, 4X



ECOLAB



IK10

