



DES FLAP



Fast fixing solution for DES splittable frames



FEATURES

- Snap fixing for the DES Series
- Gasket included
- Same holes position of the DES Systems
- IP54

The DES FLAP solution enables the DES 24, 16, 10 and Q frames to be installed with a quick snap-in connection.

The FLAP frame, once installed, hooks over the split frame and is the best solution for a flexible installation. Enclosures can be later inspected quickly and easily be dismantled.

Material: PP+GF, halogens and silicones free

Flammability: self-extinguishing acc. to UL94-V0

Temperature: -40°C... +155°C (static)

RELATED PRODUCTS

- DES 24
- DES 16
- DES 10
- DES Q
- DES Cover (page 26)
- PF cable entry system plates (page 140)

Model	Code	Dimensions (mm)		Max. cut-out (mm)	Pcs (/pack)
		L1	L2		
DES FLAP 24	1731031024	153	130	112 x 39	10
DES FLAP 16	1731031016	127	103	86 x 39	
DES FLAP 10	1731031010	106	83	63 x 39	
DES FLAP Q	1731031008	81	58	40 x 39	

Dimensions (mm)

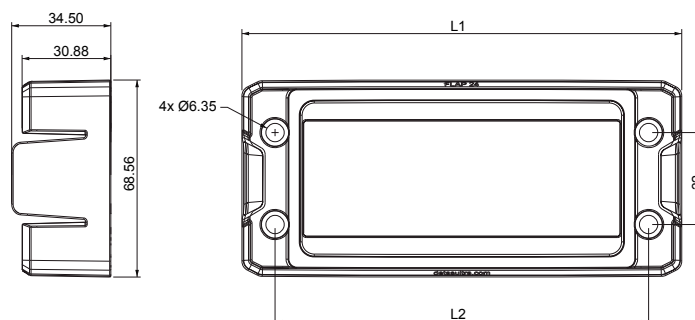

Tutorial



IP54

NEMA 12

UL TYPE 12



UL94-V0

