



# DES 24MX



## Modular frames for cables with and without connectors

### FEATURES

- Modular solution
- Multiple configurations with small and big grommets
- Frame screws in AISI304 Stainless Steel
- IP54
- Strain relief according to EN 62444
- Sturdy construction IK10
- External gasket included

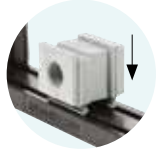







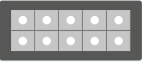

The DES 24MX splittable frames family is a modular solution for installations where a big quantity of cables need to be routed through electrical cabinets walls or panels. This solution is not only modular but it is also a general result that can be adopted as main cables entrance. Both cables with or without connector can be routed (40 for each module) and future updates can easily be organized in the cheapest and fastest way.

**Material:** PP+GF, halogens and silicones free  
**Flammability:** self-extinguishing acc. UL94-V0  
**Temperature:** -40°C... +155°C (static)

### RELATED PRODUCTS

- SPP grommets (from page 46)
- SPG grommets (from page 52)
- DES caps (page 61)

Model	Code	Some possible configurations for each module	Dimensions (mm)	Max. cut-out (mm)	Pcs (/pack)
 <b>DES 24MX2</b>	1731010252	 	146 x 115	114 x 92	1
 <b>DES 24MX3</b>	1731010253	  	146 x 166	114 x 144	
 <b>DES 24MX4</b>	1731010254	 	146 x 218	114 x 196	
<b>Other models upon request</b>					
<b>Upon request</b>	1731991020	Set of 4 mounting screws in AISI304 with Black Geomet finishing			

### Dimensions (mm)

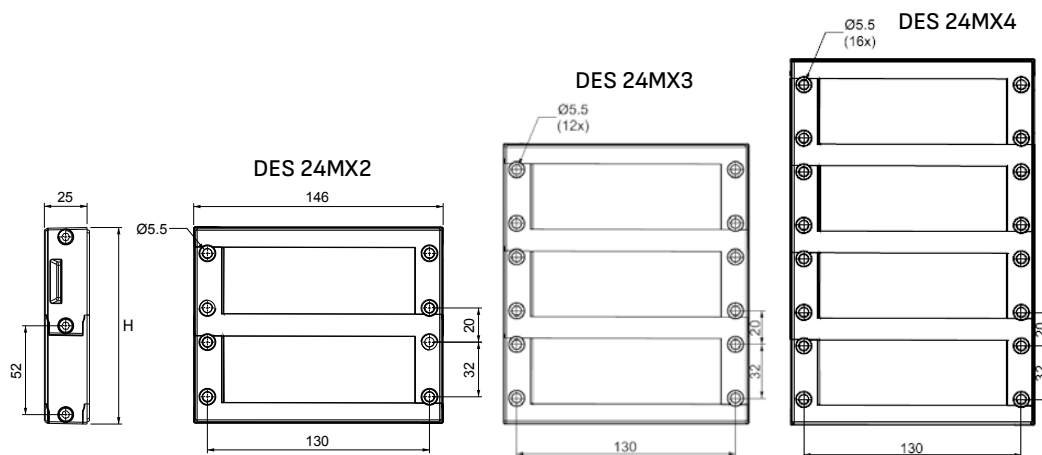

### Tutorial



IP54

NEMA 12



ECOLAB



IK10