

A

B

C

D

1

1

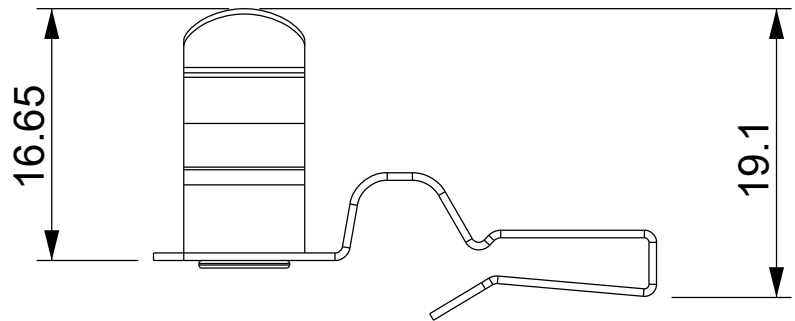
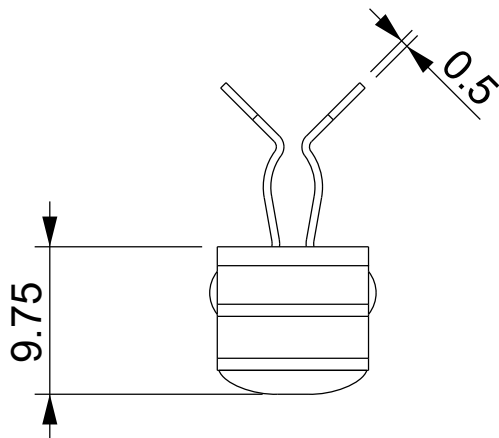

2

2

3

3

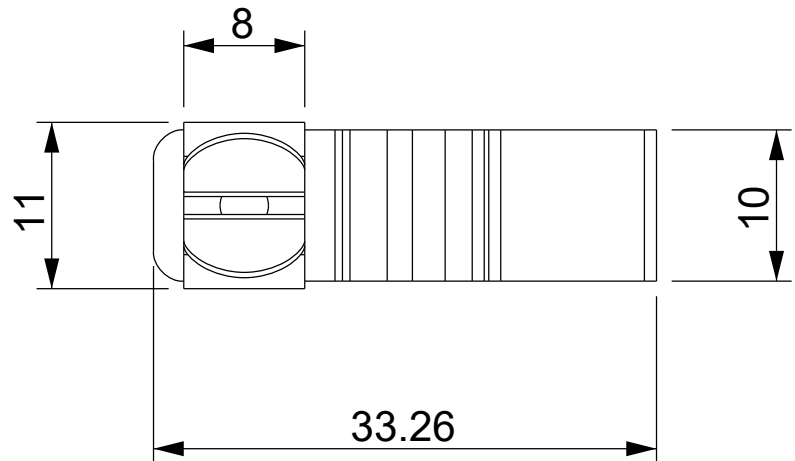
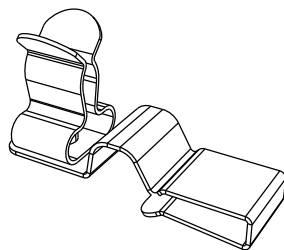

4

4

Codice / Code

1734040320

Descrizione / Description

MSR 3-6

Rev.

001

Materiale / Material  
Acciaio per molle  
zincatoColore / Color  
Grigio

Peso / Weight (g)

-

Unità di misura / Measure units  
mmFormato / Format  
A4Scala / Scale  
2:1UNI-ISO  
2768-mKData / Date  
15/10/2021Numero foglio / Sheet number  
-Numero progetto / Project number  
-Disegn. / Drawn  
ravezzano@detas.comNote / Notes  
-

www.detasultra.com

QUESTO DISEGNO E LE SUE INFORMAZIONI SONO STRETTAMENTE RISERVATE DI PROPRIETA' DETAS SPA.  
NON UTILIZZARE PER SCOPI DIVERSI DA QUELLI PER CUI SONO STATE FORNITE. DO NOT SCALE DRAWING.

A

B

C

D