

A

B

C

D

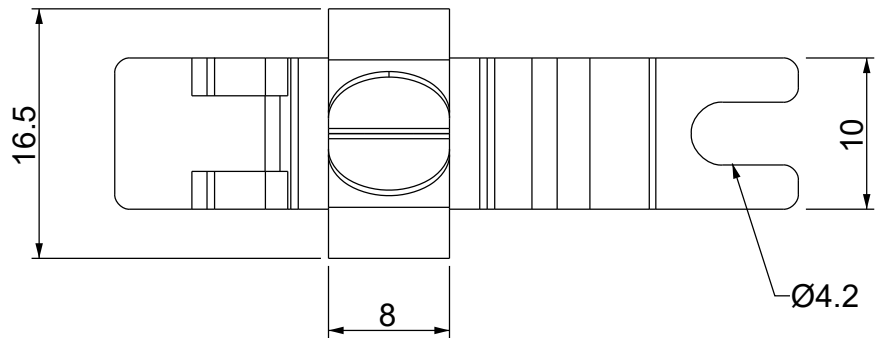
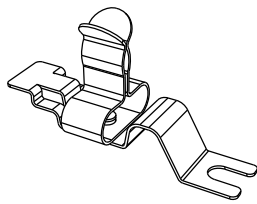
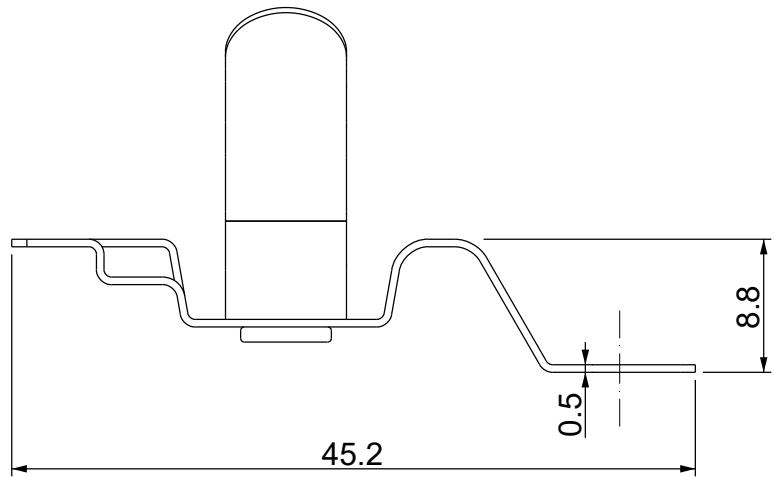
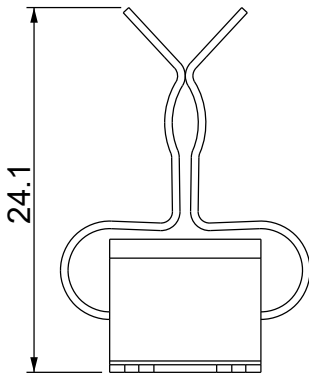

Codice / Code

1734050080

Descrizione / Description

MSEL 3-9

Rev.

002

Materiale / Material
Spring steel zinc platedColore / Color
Grey

Peso / Weight (g)

-

Unità di misura / Measure units
mmFormato / Format
A4Scala / Scale
2:1UNI-ISO
2768-mk

DETASULTRA

www.detasultra.com

QUESTO DISEGNO E LE SUE INFORMAZIONI SONO STRETTAMENTE RISERVATE DI PROPRIETÀ DETAS SPA.
NON UTILIZZARE PER SCOPI DIVERSI DA QUELLI PER CUI SONO STATE FORNITE. DO NOT SCALE DRAWING.Data / Date
13/01/2021Numero foglio / Sheet number
-Numero progetto / Project number
-Disegn. / Drawn
ravezzano@detas.comNote / Notes
-

A

B

C

D