

A

B

C

D

1

1

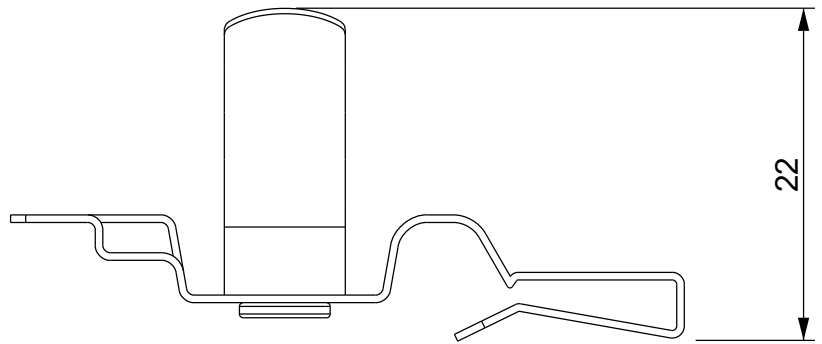
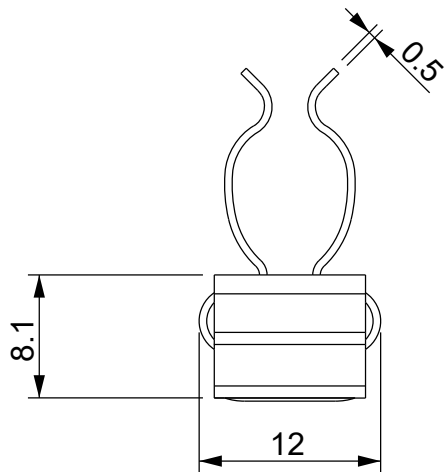

2

2

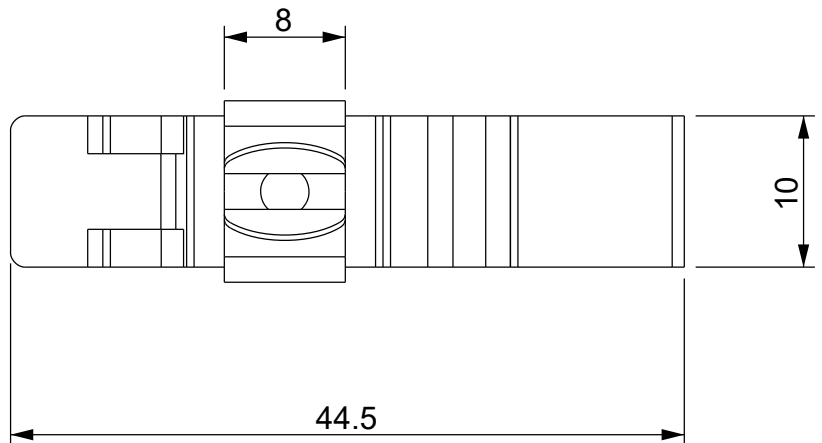
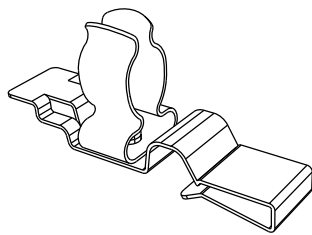

3

3

4

4

Codice / Code

1734040040

Descrizione / Description

MSB 9-12

Rev.

002

Materiale / Material
Spring steel zinc platedColore / Color
Grey

Peso / Weight (g)

-

Unità di misura / Measure units
mmFormato / Format
A4Scala / Scale
2:1Data / Date
13/01/2021Numero foglio / Sheet number
-Numero progetto / Project number
-Disegn. / Drawn
ravezzano@detas.comNote / Notes
-

QUESTO DISEGNO E LE SUE INFORMAZIONI SONO STRETTAMENTE RISERVATE DI PROPRIETA' DETAS SPA.
NON UTILIZZARE PER SCOPI DIVERSI DA QUELLI PER CUI SONO STATE FORNITE. DO NOT SCALE DRAWING.

A

B

C

D