

A

B

C

D

1

1

2

2

3

3

4

4

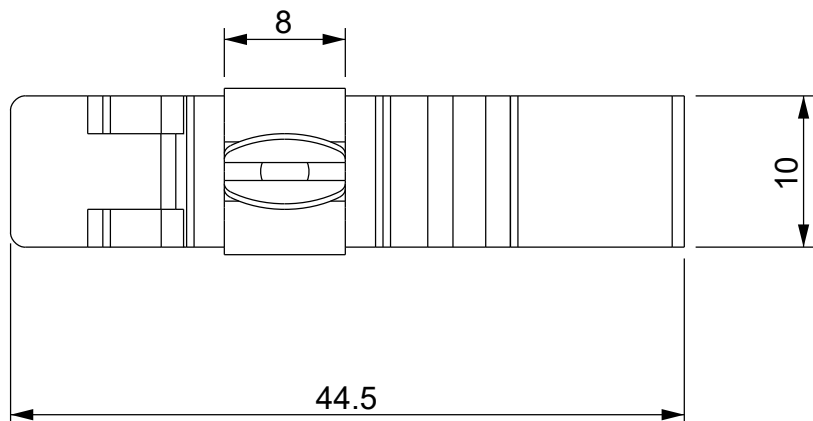
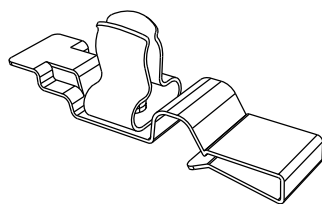
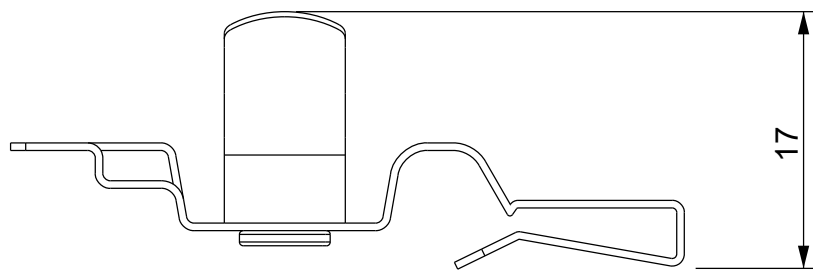
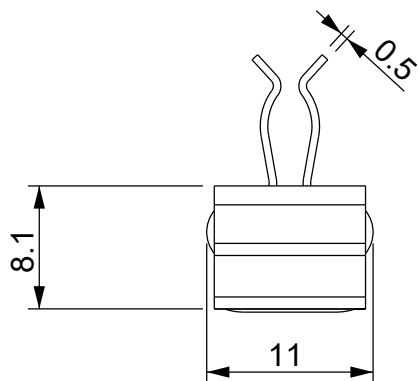

Codice / Code

1734040020

Descrizione / Description

MSB 3-6

Rev.

002

Materiale / Material
Spring steel zinc platedColore / Color
GreyPeso / Weight (g)
-Unità di misura / Measure units
mmFormato / Format
A4Scala / Scale
2:1Data / Date
13/01/2021Numero foglio / Sheet number
-Numero progetto / Project number
-Disegn. / Drawn
ravezzano@detas.comNote / Notes
-

QUESTO DISEGNO E LE SUE INFORMAZIONI SONO STRETTAMENTE RISERVATE DI PROPRIETA' DETAS SPA.
NON UTILIZZARE PER SCOPI DIVERSI DA QUELLI PER CUI SONO STATE FORNITE. DO NOT SCALE DRAWING.

A

B

C

D