

A

B

C

D

1

1

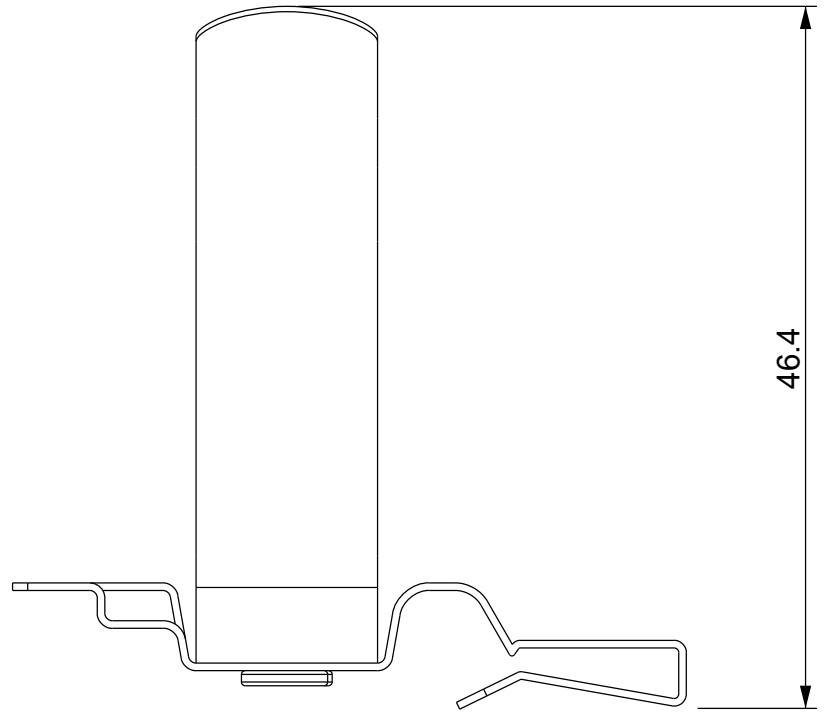
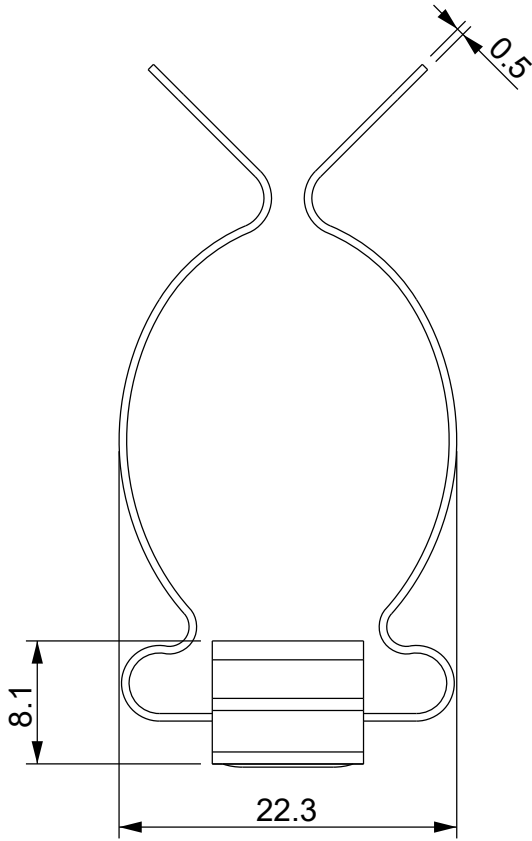

2

2

3

3

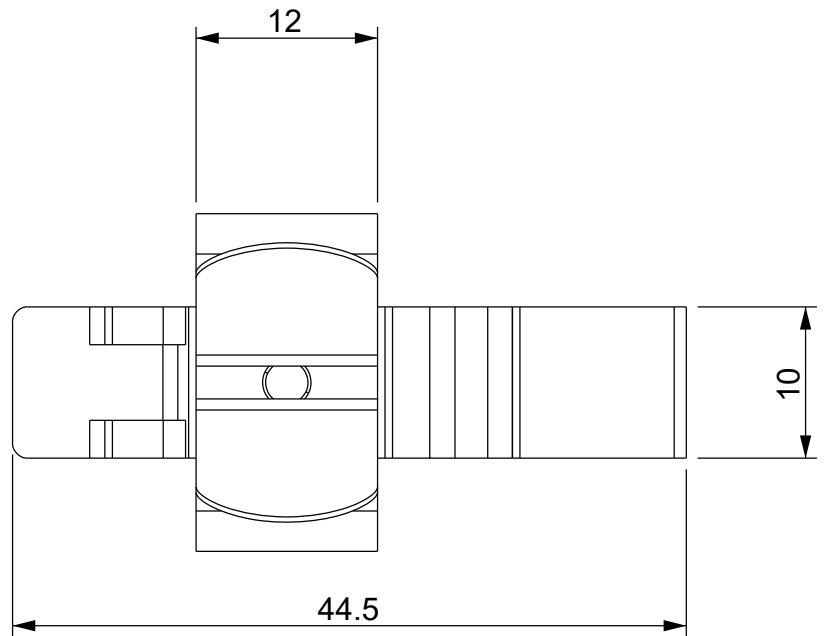
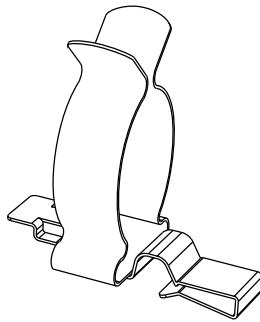

4

4

Codice / Code

1734040070

Descrizione / Description

MSB 22-30

Rev.

002

Materiale / Material  
Acciaio per molle  
zincato

Colore / Color  
Grigio

Peso / Weight (g)

-

Unità di misura / Measure units

mm

Formato / Format

A4

Scala / Scale

2:1

UNI-ISO  
2768-mK

www.detasultra.com

Data / Date

13/01/2021

Numero foglio / Sheet number

-

Numero progetto / Project number

-

Disegn. / Drawn

ravezzano@detas.com

Note / Notes

-

QUESTO DISEGNO E LE SUE INFORMAZIONI SONO STRETTAMENTE RISERVATE DI PROPRIETA' DETAS SPA.  
NON UTILIZZARE PER SCOPI DIVERSI DA QUELLI PER CUI SONO STATE FORNITE. DO NOT SCALE DRAWING.

A

B

C

D