

1

2

3

4

D

D

C

C

B

B

A

A

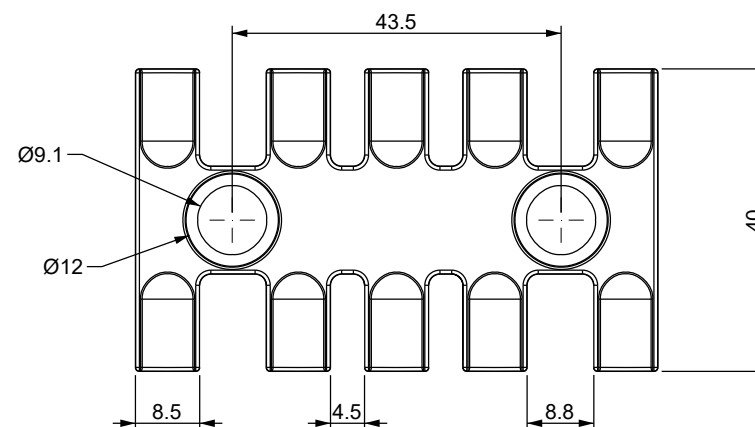
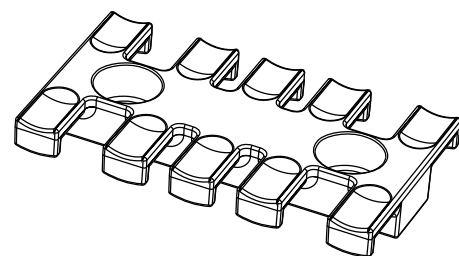
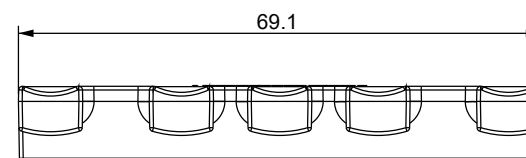
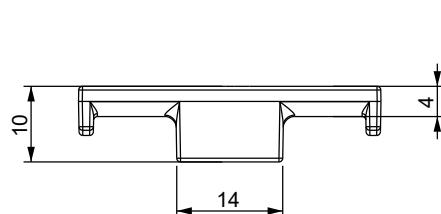

Versione con boccole:

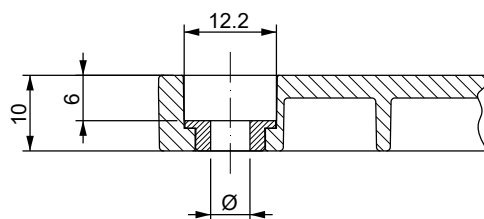

Ø4 Alluminio: 1733021405  
 Ø5 Alluminio: 1733021505  
 Ø6 Alluminio: 1733021605

Ø4 Ottone: 1733022405  
 Ø5 Ottone: 1733022505  
 Ø6 Ottone: 1733022605

**Infiammabilità:** UL94-V0, autoestinguente  
**Temperatura:** -40°C ... +140°C  
**Proprietà:** senza alogeni, senza siliceni  
**Materiale:** poliammide (PA66)

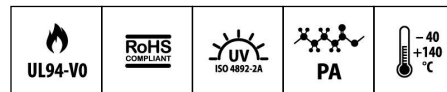

Codice / Code

1733020005

Descrizione / Description

AP 70

Rev.

003

Materiale / Material

PA66

Colore / Color

Nero

Peso / Weight (g)

-

Unità di misura / Measure units

mm

Formato / Format

A4

Scala / Scale

1:1

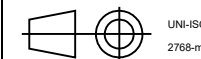

**DETASULTRA**

www.detasultra.com

QUESTO DISEGNO E LE SUE INFORMAZIONI SONO STRETTAMENTE RISERVATE DI PROPRIETÀ DETAS SPA.  
 NON UTILIZZARE PER SCOPI DIVERSI DA QUELLI PER CUI SONO STATE FORNITE. DO NOT SCALE DRAWING.

Data / Date  
23/10/2020

Disegn. / Drawn  
ravezzano@detas.com

Numero foglio / Sheet number

-

Numero progetto / Project number

-

Note / Notes

-