

A

B

C

D

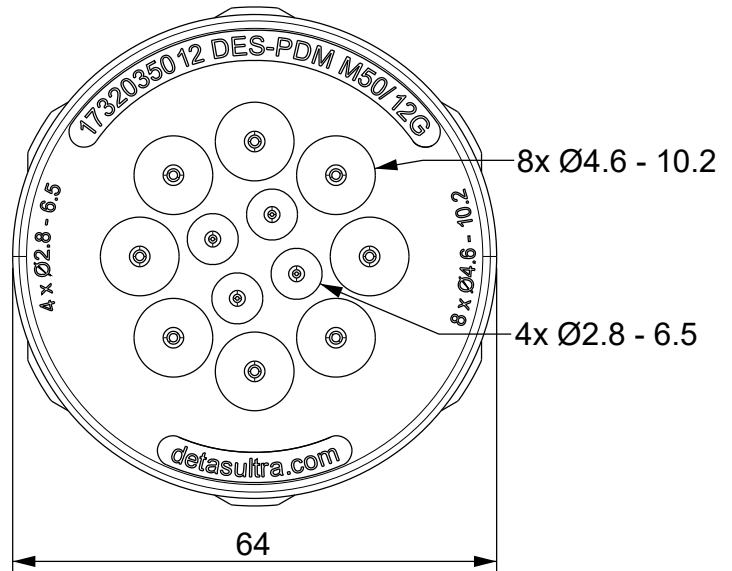
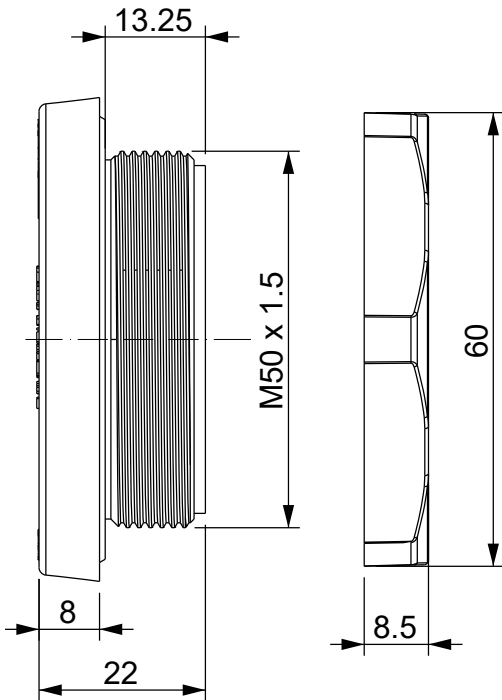
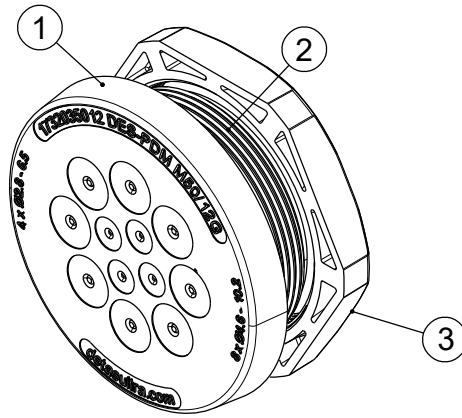

Id	Descrizione	Materiale	Q.tà
1	Corpo	TPE	1
2	Filetto	PA	1
3	Controdado	PA	1

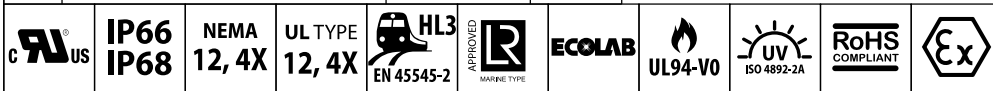

Infiammabilità: UL94-V0, autoestinguente
Temperatura: -40°C ... +105°C
Proprietà: senza alogeni, senza siliceni

Apertura consigliata:
 Ø50.5 mm

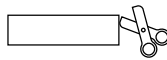

Versione ATEX:
 DES PDM M50A/12G: 1732335012
 DES PDM M50A/12B: 1732336013
 Versione colore **nero**:
 DES PDM M50/12B: 1732036013

Codice / Code

1732035012

Descrizione / Description

DES PDM M50/12G

Rev.
003Materiale / Material
see tableColore / Color
GrigioPeso / Weight (g)
-Unità di misura / Measure units
mmFormato / Format
A4Scala / Scale
1:1Data / Date
22/11/2021Numero foglio / Sheet number
-Numero progetto / Project number
-Disegn. / Drawn
ravezzano@detas.comNote / Notes
-

QUESTO DISEGNO E LE SUE INFORMAZIONI SONO STRETTAMENTE RISERVATE DI PROPRIETÀ DETAS SPA.
 NON UTILIZZARE PER SCOPI DIVERSI DA QUELLI PER CUI SONO STATE FORNITE. DO NOT SCALE DRAWING.

A

B

C

D