

A

B

C

D

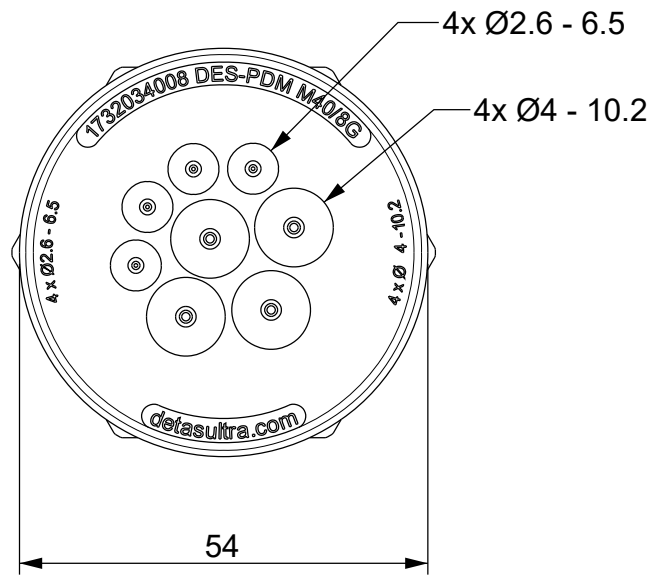
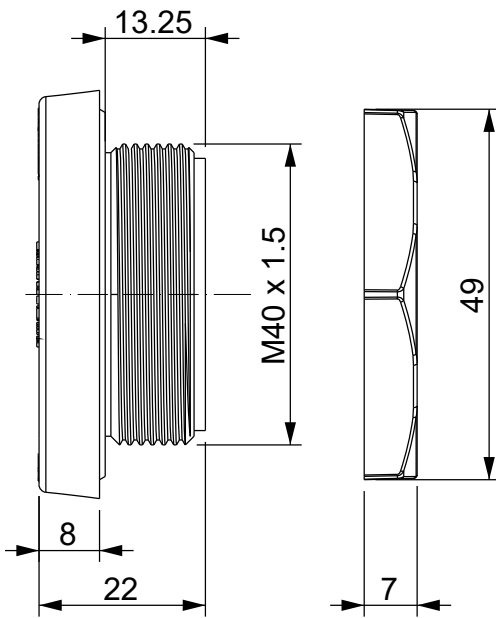
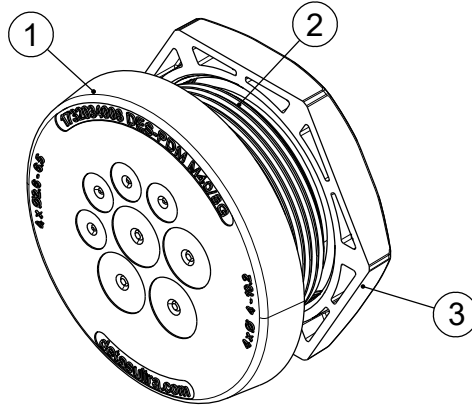

Id	Description	Material	Q.ty
1	Body	TPE	1
2	Thread	PA	1
3	Locknut	PA	1

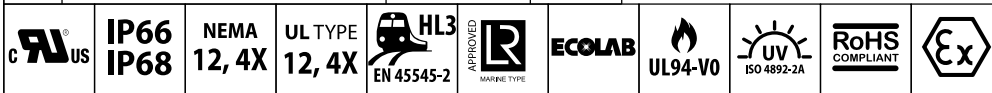

**Flammability:** UL94-V0, self-extinguishing  
**Temperature:** -40°C ... +105°C  
**Properties:** halogen-free, silicone-free

Recommended cut-out:  
 Ø40.5 mm

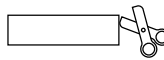

**ATEX grey version:**  
 DES PDM M40A/8G: 1732334008  
 DES PDM M40A/8B: 1732335009  
**Black color version:**  
 DES PDM M40/8B: 1732035009

Codice / Code

1732034008

Descrizione / Description

DES PDM M40/8G

Rev.

003

Materiale / Material

see table

Colore / Color

Grey

Peso / Weight (g)

-

Unità di misura / Measure units

mm

Formato / Format

A4

Scala / Scale

1:1



Data / Date

22/11/2021

Numero foglio / Sheet number

-

Numero progetto / Project number

-

Disegn. / Drawn

ravezzano@detas.com

Note / Notes

-

QUESTO DISEGNO E LE SUE INFORMAZIONI SONO STRETTAMENTE RISERVATE DI PROPRIETÀ DETAS SPA.  
 NON UTILIZZARE PER SCOPI DIVERSI DA QUELLI PER CUI SONO STATE FORNITE. DO NOT SCALE DRAWING.

A

B

C

D