

A

B

C

D

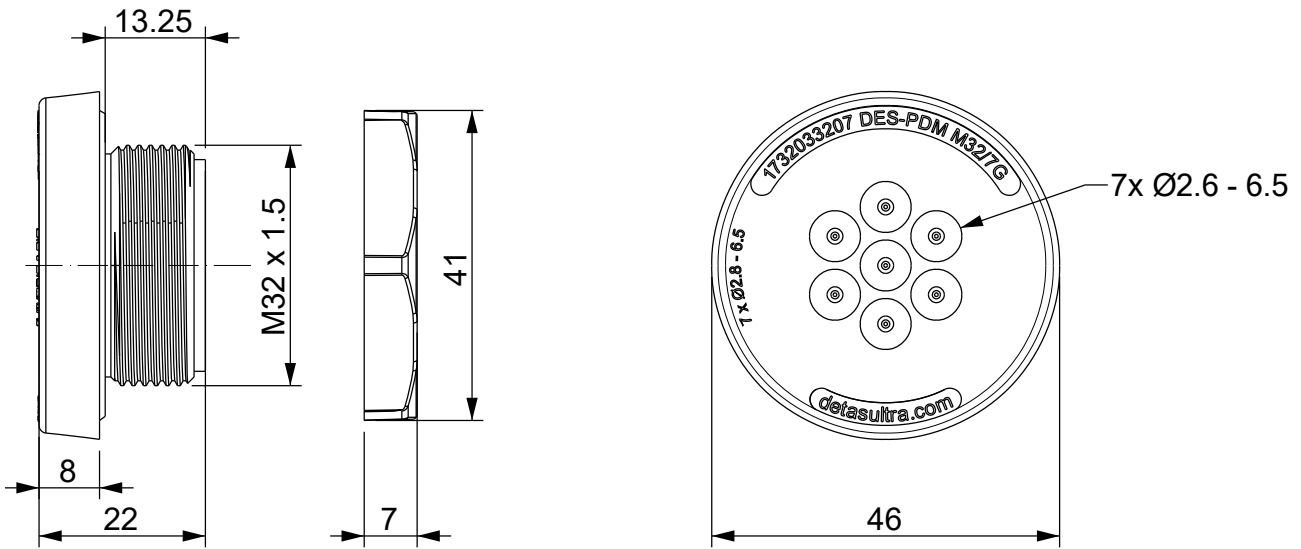
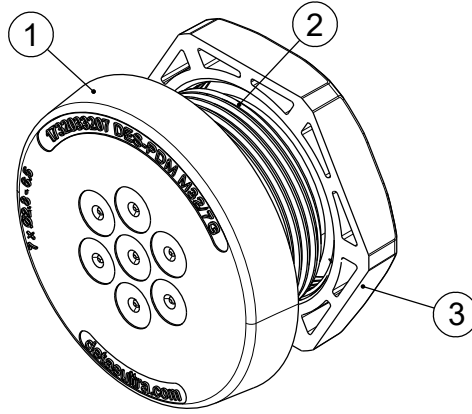

Id	Description	Material	Q.ty
1	Body	TPE	1
2	Thread	PA	1
3	Locknut	PA	1

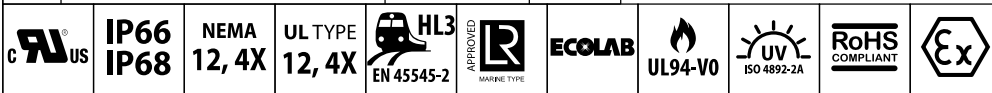

Flammability: UL94-V0, self-extinguishing
Temperature: -40°C ... +105°C
Properties: halogen-free, silicone-free

Recommended cut-out:
 Ø32.5 mm

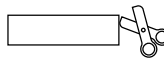

ATEX grey version:
 DES PDM M32A/7G: 1732333207
 DES PDM M32A/7B: 1732334208
Black color version:
 DES PDM M32/7B: 1732034208

Codice / Code

1732033207

Descrizione / Description

DES PDM M32/7G

Rev.

003

Materiale / Material

see table

Colore / Color

Grey

Peso / Weight (g)

-

Unità di misura / Measure units

mm

Formato / Format

A4

Scala / Scale

1:1



Data / Date

22/11/2021

Numero foglio / Sheet number

-

Numero progetto / Project number

-

Disegn. / Drawn

ravezzano@detas.com

Note / Notes

-

QUESTO DISEGNO E LE SUE INFORMAZIONI SONO STRETTAMENTE RISERVATE DI PROPRIETÀ DETAS SPA.
 NON UTILIZZARE PER SCOPI DIVERSI DA QUELLI PER CUI SONO STATE FORNITE. DO NOT SCALE DRAWING.

A

B

C

D