

A

B

C

D

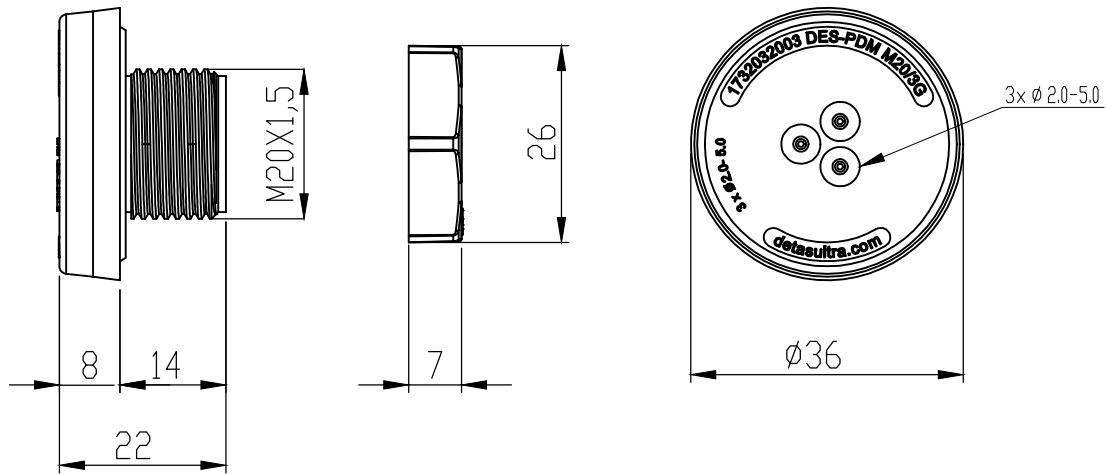
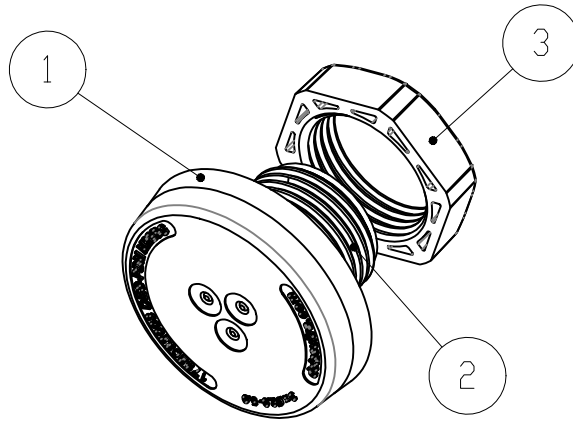

Id	Description	Material	Q.ty
1	Body	TPE	1
2	Thread	PA	1
3	Locknut	PA	1

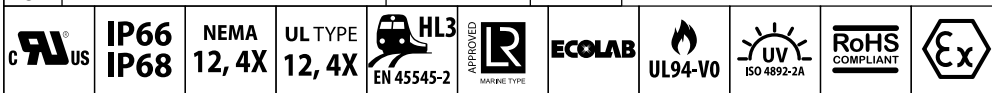

Flammability: UL94-V0, self-extinguishing
Temperature: -40°C ... +105°C
Properties: halogen-free, silicone-free

Recommended cut-out:
 Ø20.5 mm

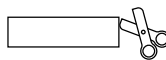

Black color version:
 DES PDM M20/3B: 1732033003

Codice / Code

1732032003

Descrizione / Description

PDM M20-3G

Rev.
000

Materiale / Material
see table

Colore / Color
Grey

Peso / Weight (g)
-

Unità di misura / Measure units
mm

Formato / Format
A4

Scala / Scale
1:1



Data / Date
23/02/2024

Numero foglio / Sheet number
-

Numero progetto / Project number
-

Disegn. / Drawn
Pozzi F.

Note / Notes
-

QUESTO DISEGNO E LE SUE INFORMAZIONI SONO STRETTAMENTE RISERVATE DI PROPRIETÀ DETAS SPA.
 NON UTILIZZARE PER SCOPI DIVERSI DA QUELLI PER CUI SONO STATE FORNITE. DO NOT SCALE DRAWING.

A

B

C

D