

A

B

C

D

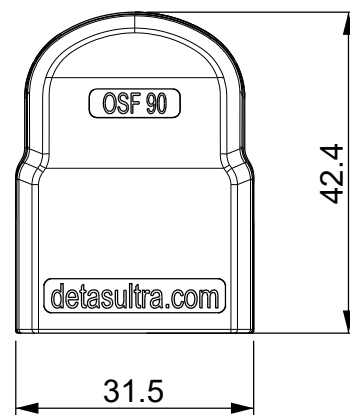
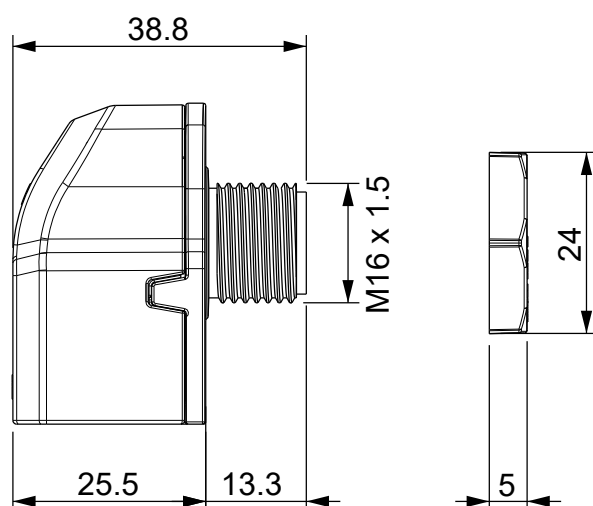
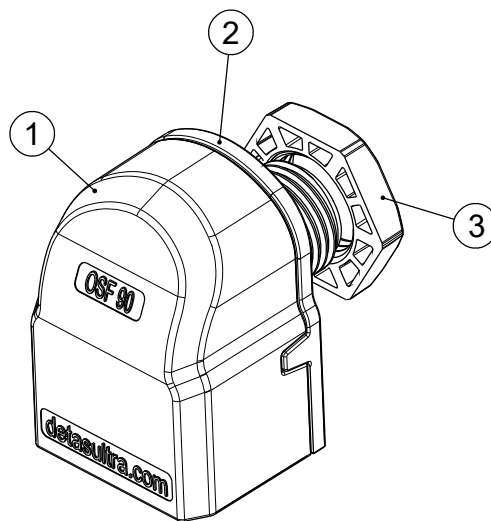

Id	Description	Material	Q.ty
1	Cover	PC	1
2	Body	PC	1
3	M16 Locknut	PA	1
4	Gasket (not shown)	NBR	1

Maximum recommended insert size

Single (SPC)	Double (SPC 2X)	Quadruple (SPC 4X)
SPC 10	SPC 2x4	SPC 4x4

	<b>IP54</b>	<b>NEMA 12</b>	<b>UL TYPE 12</b>					<b>IK10</b>
--	-------------	----------------	-------------------	--	--	--	--	-------------

**Flammability:** UL94-V0, self-extinguishing  
**Temperature:** -40°C ... +130°C  
**Properties:** halogen-free, silicone-free

Recommended cut-out:  
 Ø16.5mm

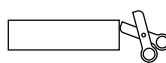

GREY color version:  
 1731052916 OSF 90 16G

Codice / Code

**1731052917**

Descrizione / Description

**OSF 90 16B**

Rev.

003

Materiale / Material

See table

Colore / Color

Black

Peso / Weight (g)

-

Unità di misura / Measure units

mm

Formato / Format

A4

Scala / Scale

1:1



www.detasultra.com

Data / Date

26/07/2023

Numero foglio / Sheet number

-

Numero progetto / Project number

-

Disegn. / Drawn

ravezzano@detas.com

Note / Notes

-

QUESTO DISEGNO E LE SUE INFORMAZIONI SONO STRETTAMENTE RISERVATE DI PROPRIETA' DETAS SPA. NON UTILIZZARE PER SCOPI DIVERSI DA QUELLI PER CUI SONO STATE FORNITE. DO NOT SCALE DRAWING.

A

B

C

D