

A

B

C

D

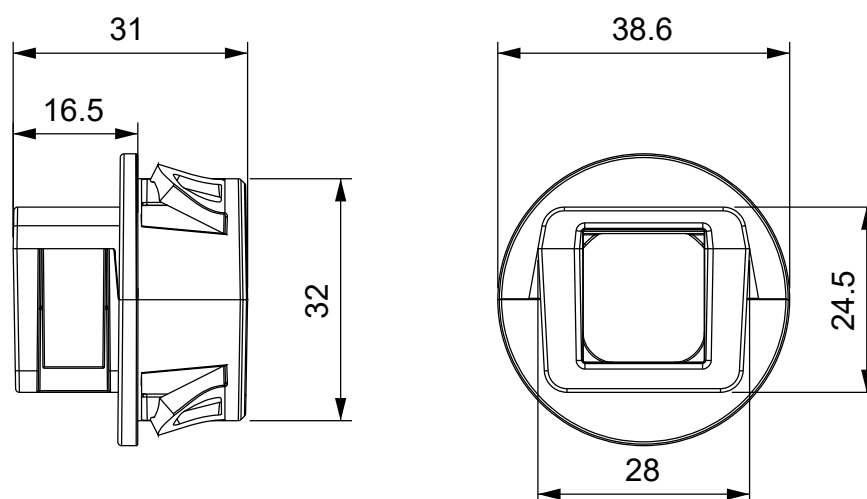
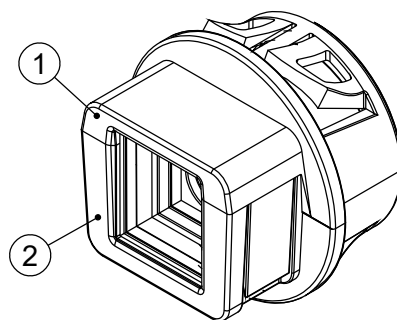

Id	Description	Material	Q.ty
1	OSF ZIP Top	PC	1
2	OSF ZIP Bottom	PC	1
3	Gasket (not shown)	NBR	1

Maximum recommended insert size

Single (SPC)	Double (SPC 2X)	Quadruple (SPC 4X)
SPC 14	SPC 2x7	SPC 4x6

	IP54	NEMA 12	UL TYPE 12					IK10
--	-------------	----------------	-------------------	--	--	--	--	-------------

Flammability: UL94-V0, self-extinguishing
Temperature: -40°C ... +130°C
Properties: halogen-free, silicone-free

Recommended cut-out:
 Ø32.5mm



GREY color version:
 1731052732 OSF ZIP 32G

Codice / Code

1731052832

Descrizione / Description

OSF ZIP 32B

Rev.

003

Materiale / Material

see table

Colore / Color

Black

Peso / Weight (g)

-

Unità di misura / Measure units

mm

Formato / Format

A4

Scala / Scale

1:1



Data / Date

26/07/2023

Numero foglio / Sheet number

-

Numero progetto / Project number

-

Disegn. / Drawn

ravezzano@detas.com

Note / Notes

-



www.detasultra.com

QUESTO DISEGNO E LE SUE INFORMAZIONI SONO STRETTAMENTE RISERVATE DI PROPRIETÀ DETAS SPA. NON UTILIZZARE PER SCOPI DIVERSI DA QUELLI PER CUI SONO STATE FORNITE. DO NOT SCALE DRAWING.

A

B

C

D