

A

B

C

D

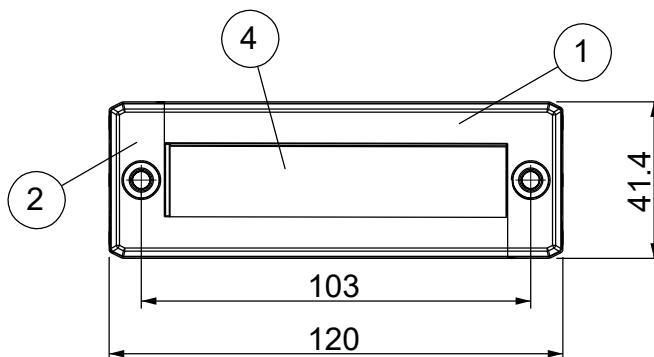
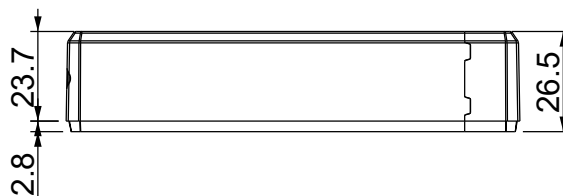
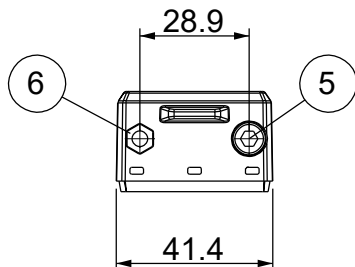
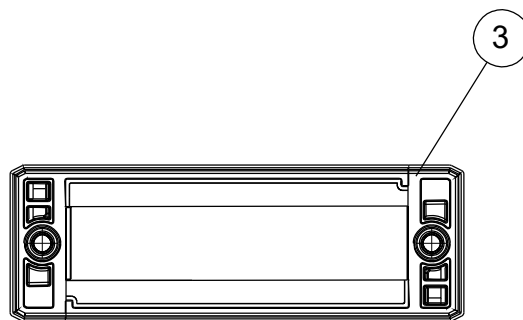
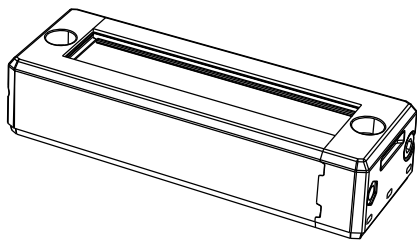

Nr.	Descrizione	Materiale	Q.tà
1	Telaio - parte 1	PP + GF	1
2	Telaio - parte 2	PP + GF	1
3	Guarnizione	TPE	1
4	Spazzola	PA	2
5	Vite	SS304	2
6	Dado	SS304	2

Infiammabilità: UL94-V0, autoestinguente
Temperatura: -40°C ... +155°C
Proprietà: senza alogeni, senza siliceni

Apertura consigliata:
86 x 18 mm

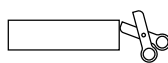

Codice / Code

1731060204

Descrizione / Description

DES ZZ L4

Rev.

002

Materiale / Material

Colore / Color

Peso / Weight (g)

Unità di misura / Measure units

Formato / Format

Scala / Scale

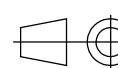

UNI-ISO
2768-mk



Data / Date
26/07/2023

Numero foglio / Sheet number

-

Numero progetto / Project number

-

Disegn. / Drawn

ravezzano@detas.com

Note / Notes

-

QUESTO DISEGNO E LE SUE INFORMAZIONI SONO STRETTAMENTE RISERVATE DI PROPRIETÀ DETAS SPA.
NON UTILIZZARE PER SCOPI DIVERSI DA QUELLI PER CUI SONO STATE FORNITE. DO NOT SCALE DRAWING.

A

B

C

D