

A

B

C

D

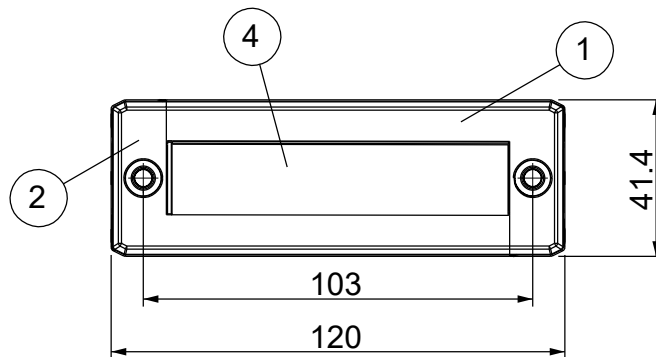
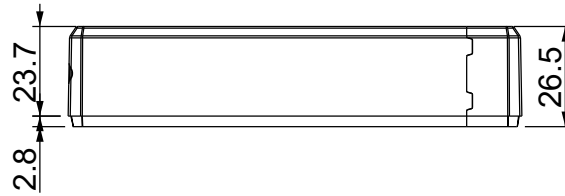
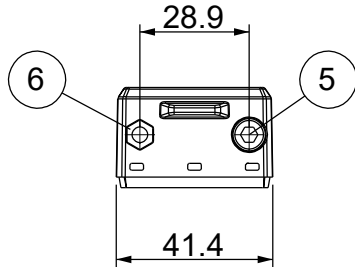
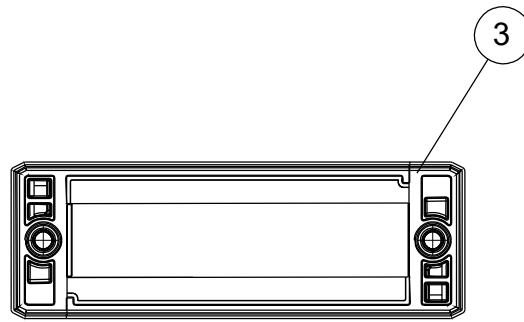
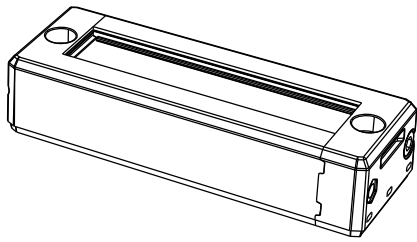

Nr.	Description	Material	Q.ty
1	Frame - Part 1	PP + GF	1
2	Frame - Part 2	PP + GF	1
3	Gasket	TPE	1
4	Brush	PA	2
5	Screw	SS304	2
6	Nut	SS304	2

Flammability: UL94-V0, self-extinguishing
Temperature: -40°C ... +155°C
Properties: halogen-free, silicone-free

Recommended cut-out:
86 x 18 mm

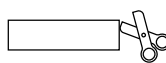

Codice / Code

1731060204

Descrizione / Description

DES ZZ L4

Rev.

002

Materiale / Material

Colore / Color

Peso / Weight (g)

Unità di misura / Measure units

Formato / Format

Scala / Scale

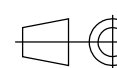

UNI-ISO
2768-mk



www.detasultra.com

Data / Date
26/07/2023

Numero foglio / Sheet number

-

Numero progetto / Project number

-

Disegn. / Drawn

ravezzano@detas.com

Note / Notes

-

QUESTO DISEGNO E LE SUE INFORMAZIONI SONO STRETTAMENTE RISERVATE DI PROPRIETÀ DETAS SPA.
NON UTILIZZARE PER SCOPI DIVERSI DA QUELLI PER CUI SONO STATE FORNITE. DO NOT SCALE DRAWING.

A

B

C

D