

| Nr. | Descrizione | Materiale | Q.tà |
|-----|------------------|-----------|------|
| 1 | Telaio - parte 1 | PP + GF | 1 |
| 2 | Telaio - parte 2 | PP + GF | 1 |
| 3 | Guarnizione | TPE | 1 |
| 4 | Spazzola | PA | 2 |
| 5 | Vite | SS304 | 2 |
| 6 | Dado | SS304 | 2 |

Infiammabilità: UL94-V0, autoestinguente
Temperatura: -40°C ... +155°C
Proprietà: senza alogeni, senza siliconi

Apertura consigliata:
63 x 18 mm

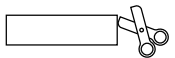

| | | | | | |
|--|--|--|--|--|--|
| | | | | | |
|--|--|--|--|--|--|

Codice / Code
1731060203

Descrizione / Description
DES ZZ L3

Rev.
002

Materiale / Material
-

Colore / Color
Nero

Peso / Weight (g)
-

Unità di misura / Measure units
mm

Formato / Format
A4

Scala / Scale
1:2



Data / Date
26/07/2023

Numero foglio / Sheet number
-

Numero progetto / Project number
-

Disegn. / Drawn
ravezzano@detas.com

Note / Notes
-

QUESTO DISEGNO E LE SUE INFORMAZIONI SONO STRETTAMENTE RISERVATE DI PROPRIETÀ DETAS SPA. NON UTILIZZARE PER SCOPI DIVERSI DA QUELLI PER CUI SONO STATE FORNITE. DO NOT SCALE DRAWING.