

A

B

C

D

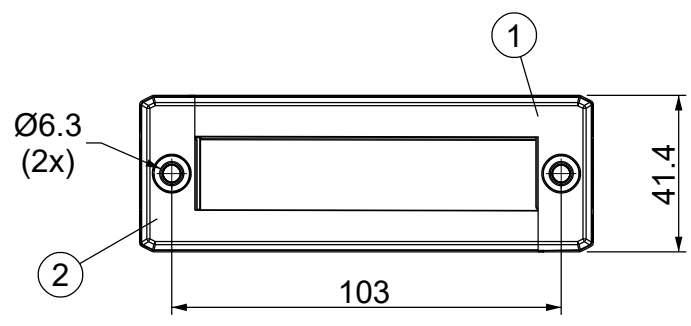
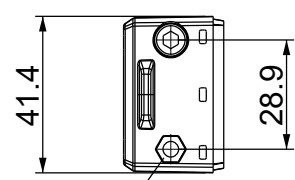
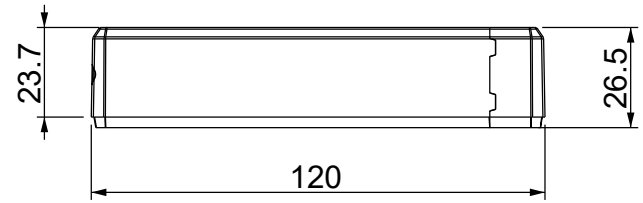
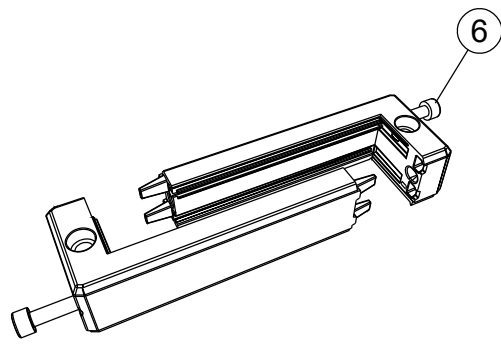
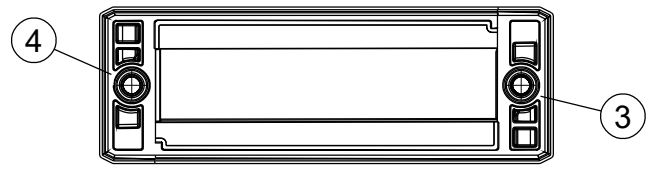
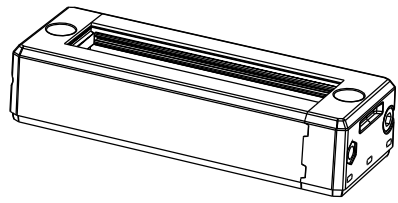

5

Ø6.3
(2x)

2

Id	Descrizione	Materiale	Q.tà
1	DES L4 Superiore	PP + GF	1
2	DES L4 Inferiore	PP + GF	1
3	DES L4 guarnizione sup.	TPE	1
4	DES L4 guarnizione inf.	TPE	1
5	Dado (Finit. Black Dacromet)	A2(SS304)	2
6	Vite TCEI M5x0.8 L=114	A2(SS304)	2

	IP66	NEMA 4X	NEMA 12	 EN 45545-2		ECOLAB			RoHS COMPLIANT	IK10				
--	-------------	----------------	----------------	----------------	--	---------------	--	--	-----------------------	-------------	--	--	--	--

Infiammabilità: UL94-V0, autoestinguente
Temperatura: -40°C ... +155°C
Proprietà: senza alogeni, senza siliconi

Apertura consigliata:
86 x 18 mm

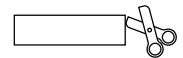

Disponibile versione ATEX:
DES L4 A - 1731310004

Disponibile con inserti filettati:
DES L4 FT - 1731410004

Codice / Code
1731010004

Descrizione / Description
DES L4

Rev.
004

Materiale / Material see table	Colore / Color Nero	Peso / Weight (g) 120.4
-----------------------------------	------------------------	----------------------------

Unità di misura / Measure units mm

Formato / Format A4

Scala / Scale 1:2



Data / Date 26/07/2023

Numero foglio / Sheet number -

Numero progetto / Project number -

Disegn. / Drawn ravezzano@detas.com
--

Note / Notes -

QUESTO DISEGNO E LE SUE INFORMAZIONI SONO STRETTAMENTE RISERVATE DI PROPRIETÀ DETAS SPA. NON UTILIZZARE PER SCOPI DIVERSI DA QUELLI PER CUI SONO STATE FORNITE. DO NOT SCALE DRAWING.

A

B

C

D