

A

B

C

D

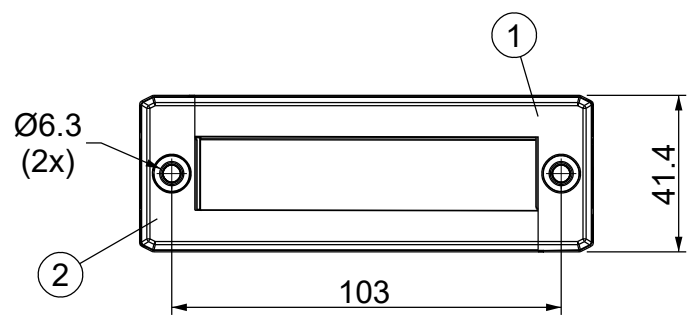
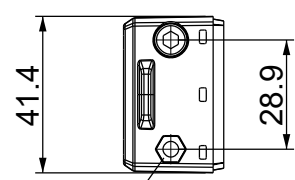
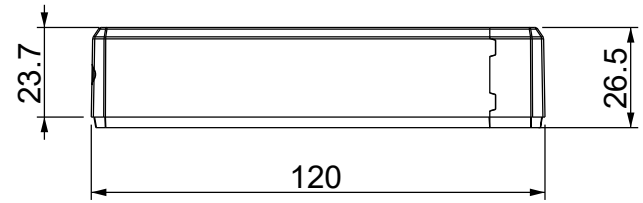
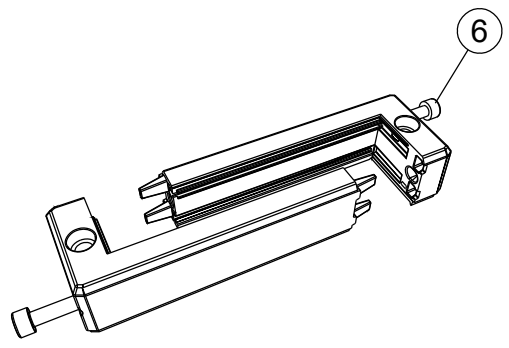
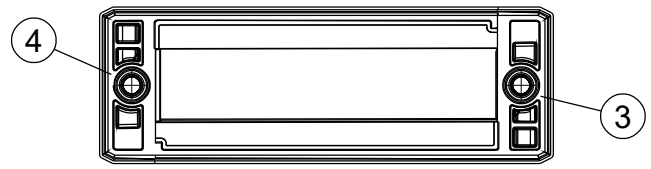
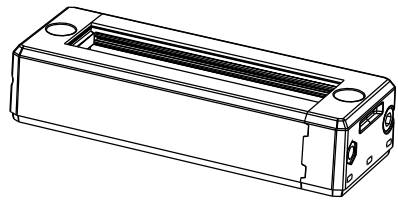

5

2

1

Id	Description	Material	Q.ty
1	DES L4 Top	PP + GF	1
2	DES L4 Bottom	PP + GF	1
3	DES L4 Gasket Top	TPE	1
4	DES L4 Gasket Bottom	TPE	1
5	Nut (Black dacromet finishing)	SS304	2
6	Screw Hex M5x0.8 L=114	SS304	2



Flammability: UL94-V0, self-extinguishing
Temperature: -40°C ... +155°C
Properties: halogen-free, silicone-free

Recommended cut-out:
86 x 18 mm

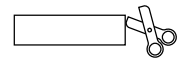

Available ATEX version:
DES L4 A - 1731310004

Available with threaded inserts:
DES L4 FT - 1731410004

Codice / Code
1731010004

Descrizione / Description
DES L4

Rev.
004

Materiale / Material
see table

Colore / Color
Black

Peso / Weight (g)
120.4

Unità di misura / Measure units
mm

Formato / Format
A4

Scala / Scale
1:2



QUESTO DISEGNO E LE SUE INFORMAZIONI SONO STRETTAMENTE RISERVATE DI PROPRIETA' DETAS SPA. NON UTILIZZARE PER SCOPI DIVERSI DA QUELLI PER CUI SONO STATE FORNITE. DO NOT SCALE DRAWING.

Data / Date
26/07/2023

Numero foglio / Sheet number
-

Numero progetto / Project number
-

Disegn. / Drawn
ravezzano@detas.com

Note / Notes
-

A

B

C

D