

A

B

C

D

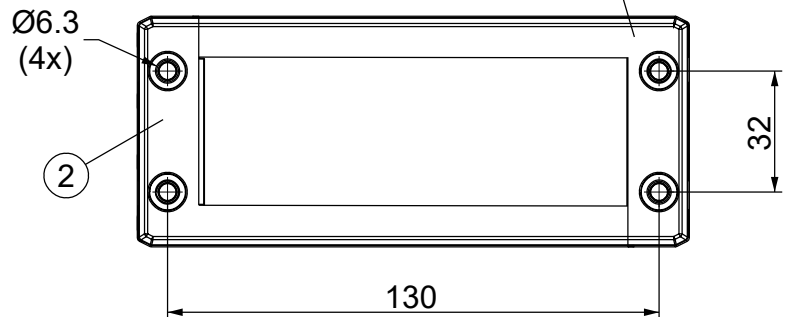
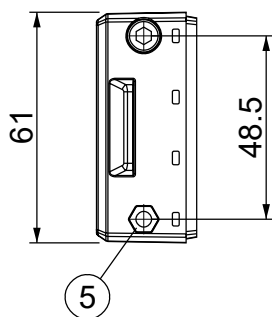
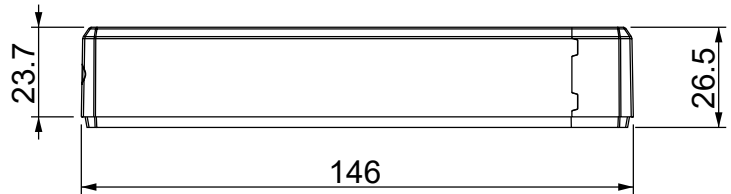
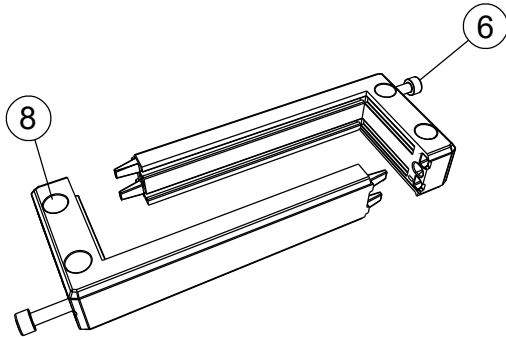
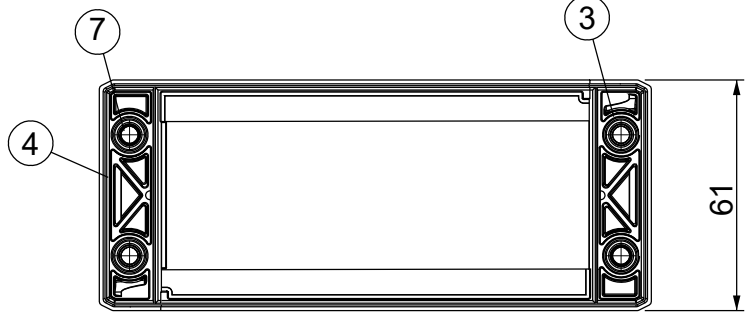
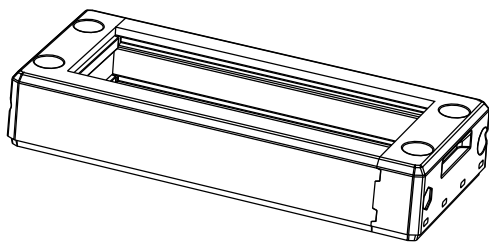

Id	Description	Material	Q.ty
1	DES Top	PP + GF	1
2	DES Bottom	PP + GF	1
3	DES Gasket Top	TPE	1
4	DES Gasket Bottom	TPE	1
5	Nut (Black dacromet finishing)	SS304	2
6	Screw Hex M5x0.8	SS304	2
7	M4 insert	Brass	4
8	Caps	PP	4

**Flammability:** UL94-V0, self-extinguishing  
**Temperature:** -40°C ... +155°C  
**Properties:** halogen-free, silicone-free

Recommended cut-out:  
112 x 39 mm

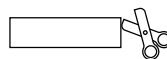

Codice / Code

1731410024

Descrizione / Description

DES 24-FT

Rev.

001

Materiale / Material

see table

Colore / Color

Black

Peso / Weight (g)

156.6

Unità di misura / Measure units

mm

Formato / Format

A4

Scala / Scale

1:2



www.detasultra.com

Data / Date

26/07/2023

Numero foglio / Sheet number

-

Numero progetto / Project number

-

Disegn. / Drawn

Pozzi F.

Note / Notes

-

QUESTO DISEGNO E LE SUE INFORMAZIONI SONO STRETTAMENTE RISERVATE DI PROPRIETÀ DETAS SPA.  
 NON UTILIZZARE PER SCOPI DIVERSI DA QUELLI PER CUI SONO STATE FORNITE. DO NOT SCALE DRAWING.

A

B

C

D