

A

B

C

D

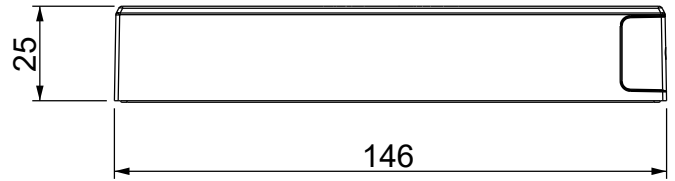
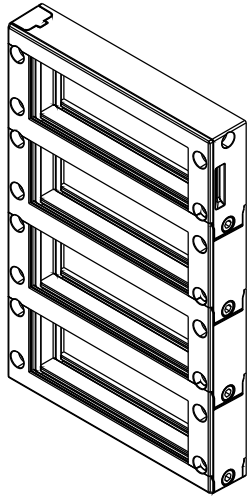

Ø5.5
(16x)

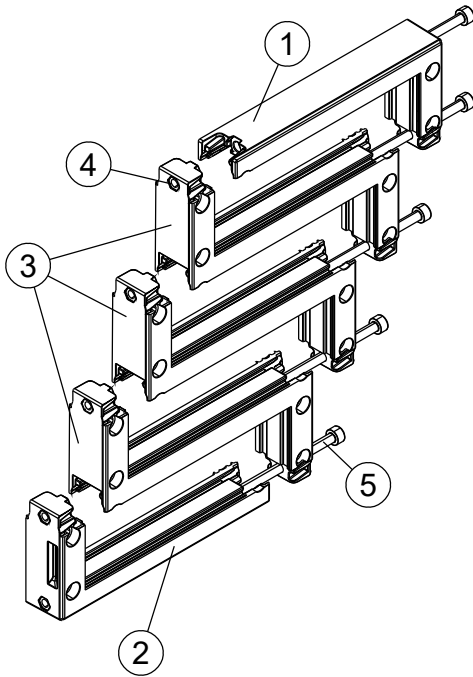
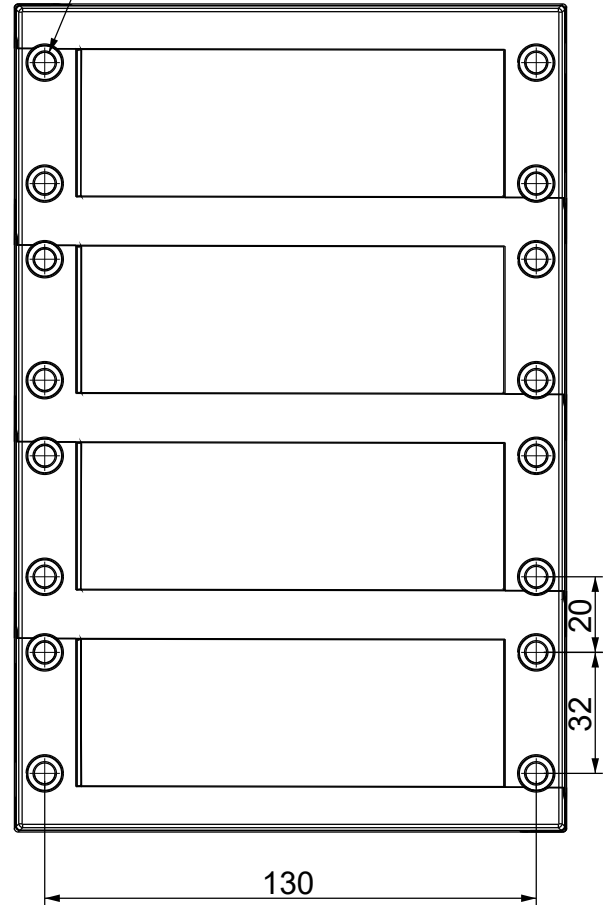
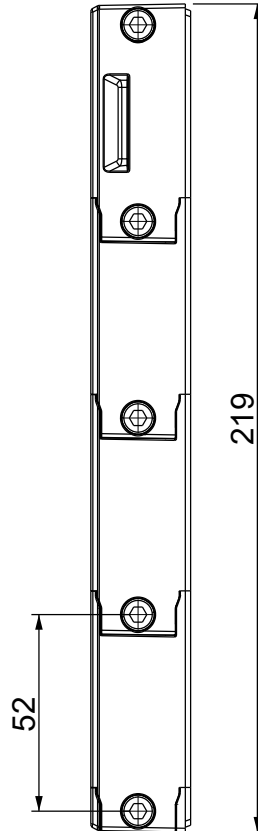

Id	Descrizione	Materiale	Q.tà
1	DES 24M Superiore	PP + GF	1
2	DES 24M Inferiore	PP + GF	1
3	DES 24M Centrale	PP + GF	3
4	Dado (Finit. Black Dacromet)	A2(SS304)	5
5	Vite TCEI M5x0.8 L=140	A2(SS304)	5
6	Guarnizione (non visibile)	NBR	1



Infiammabilità: UL94-V0, autoestinguente
Temperatura: -40°C ... +155°C
Proprietà: senza alogeni, senza siliceni

Apertura consigliata:
114 x 196 mm

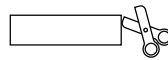

Codice / Code

1731010254

Descrizione / Description

DES 24 MX4

Rev.

003

Materiale / Material

see table

Colore / Color

Nero

Peso / Weight (g)

-

Unità di misura / Measure units

mm

Formato / Format

A4

Scala / Scale

1:2

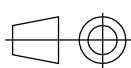

UNI-ISO
2768-mk



Data / Date
26/07/2023

Numero foglio / Sheet number

-

Numero progetto / Project number

-

Disegn. / Drawn

ravezzano@detas.com

Note / Notes

-

QUESTO DISEGNO E LE SUE INFORMAZIONI SONO STRETTAMENTE RISERVATE DI PROPRIETÀ DETAS SPA. NON UTILIZZARE PER SCOPI DIVERSI DA QUELLI PER CUI SONO STATE FORNITE. DO NOT SCALE DRAWING.

A

B

C

D