

A

B

C

D

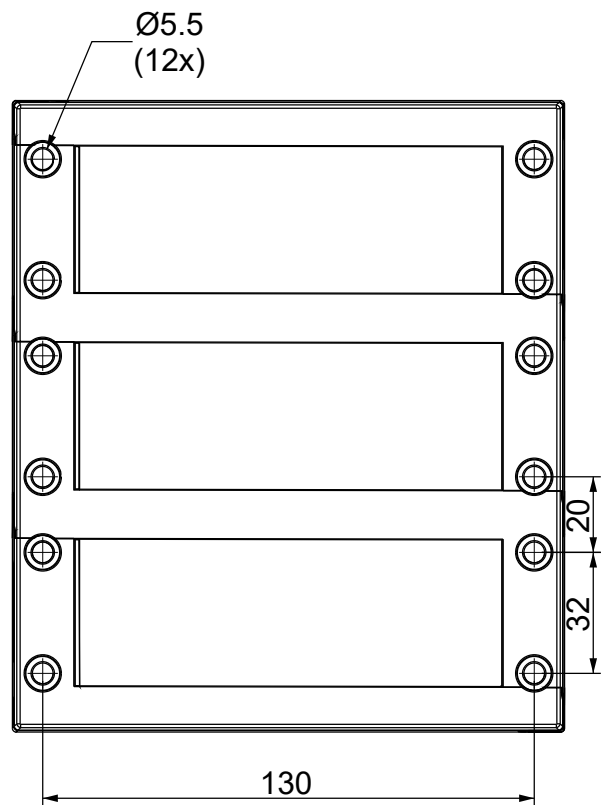
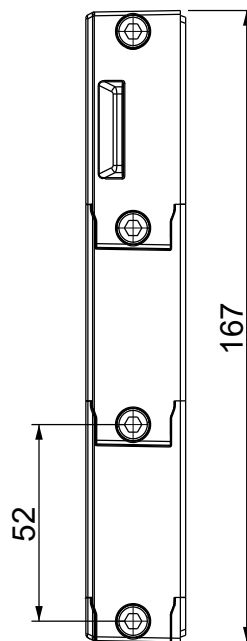
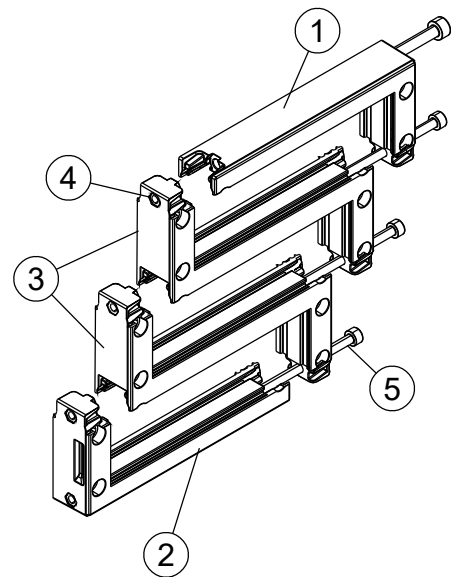
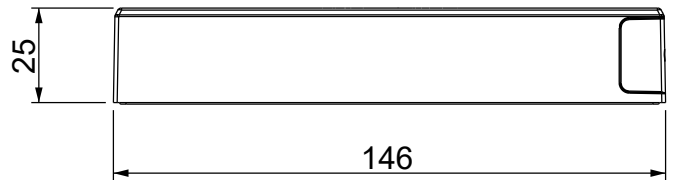
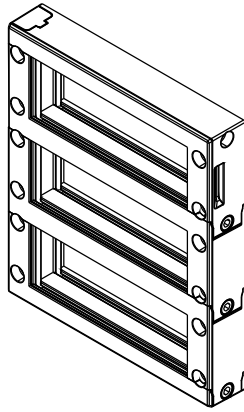

Id	Description	Material	Q.ty
1	DES 24M Top	PP + GF	1
2	DES 24M Bottom	PP + GF	1
3	DES 24M Middle	PP + GF	2
4	Nut (Black dacromet finishing)	SS304	4
5	Screw Hex M5x0.8 L=140	SS304	4
6	Gasket (not shown)	NBR	1



Flammability: UL94-V0, self-extinguishing
Temperature: -40°C ... +155°C
Properties: halogen-free, silicone-free

Recommended cut-out:
114 x 144 mm

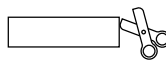

IP54

NEMA 12



ECOLAB



RoHS COMPLIANT

IK10



Codice / Code

1731010253

Descrizione / Description

DES 24 MX3

Rev.

003

Materiale / Material

see table

Colore / Color

Black

Peso / Weight (g)

-

Unità di misura / Measure units

mm

Formato / Format

A4

Scala / Scale

1:2

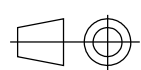

UNI-ISO
2768-mk



Data / Date

26/07/2023

Numero foglio / Sheet number

-

Numero progetto / Project number

-

Disegn. / Drawn

ravezzano@detas.com

Note / Notes

-

QUESTO DISEGNO E LE SUE INFORMAZIONI SONO STRETTAMENTE RISERVATE DI PROPRIETA' DETAS SPA. NON UTILIZZARE PER SCOPI DIVERSI DA QUELLI PER CUI SONO STATE FORNITE. DO NOT SCALE DRAWING.

A

B

C

D